

HEAT TREATMENT OF TOOL STEEL

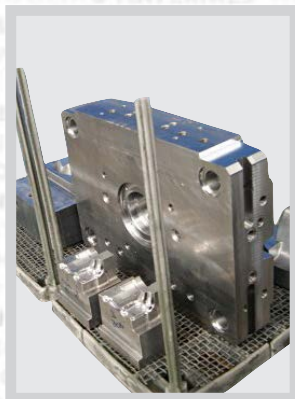

Cover photos from left to right: Böhler Uddeholm Czech Republic,
Uddeholms AB/HÄRDteknö, Eifeler Werkzeuge, Germany.

© UDDEHOLMS AB

No part of this publication may be reproduced or transmitted for commercial purposes
without permission of the copyright holder.

This information is based on our present state of knowledge and is intended to provide general
notes on our products and their uses. It should not therefore be construed as a warranty of
specific properties of the products described or a warranty for fitness for a particular purpose.

Classified according to EU Directive 1999/45/EC
For further information see our "Material Safety Data Sheets".

Edition 8, Revised 06.2012, not printed

The latest revised edition of this brochure is the English version,
which is always published on our web site www.uddeholm.com



SS-EN ISO 9001
SS-EN ISO 14001

CONTENTS

What is tool steel?	4
Hardening and tempering	4
Dimensional and shape stability	11
Surface treatment	12
Testing of mechanical properties	14
Some words of advice to tool designers	15
Hardness after hardening and tempering	17
Hardness conversion table	18

The purpose of this brochure is to provide a general idea of how tool steel is heat treated and how it behaves during this process. Special attention is paid to hardness, toughness and dimensional stability.

What is tool steel?

Tool steels are high-quality steels made to controlled chemical composition and processed to develop properties useful for working and shaping of other materials. The carbon content in tool steels may range from as low as 0.1% to as high as more than 1.6% C and many are alloyed with alloying elements such as chromium, molybdenum and vanadium.

Tool steels are used for applications such as blanking and forming, plastic moulding, die casting, extrusion and forging.

Alloy design, the manufacturing route of the steel and quality heat treatment are key factors in order to develop tools or parts with the enhanced properties that only tool steel can offer.

Benefits like durability, strength, corrosion resistance and high-temperature stability are also attractive for other purposes than pure tool applications. For this reason, tool steel is a better choice than construction or engineering steel for strategic components in the different industries.

More advanced materials easily result in lower maintenance costs,

lighter parts, greater precision and increased reliability.

Uddeholm has concentrated its tool steel range on high alloyed types of steel, intended primarily for purposes such as plastic moulding, blanking and forming, die casting, extrusion, forging, wood-working industry, recycling industry and component business. Powder metallurgy (PM) steels are also included in the range.

Tool steel is normally delivered in the soft annealed condition; this makes the material easy to machine with cutting tools and it provides a microstructure suitable for hardening.

The soft annealed microstructure consists of a soft matrix in which carbides are embedded. See picture below.

In carbon steel, these carbides are iron carbides, while in alloyed steel they are chromium (Cr), tungsten (W), molybdenum (Mo) or vanadium (V) carbides, depending on the composition of the steel. Carbides are compounds of carbon and alloying elements and are characterized by very high hardness. Higher carbide content means a higher resistance to wear.

Also non-carbide forming alloying elements are used in tool steel, such as cobalt (Co) and nickel (Ni) which are dissolved in the matrix. Cobalt is normally used to improve red hardness in high speed steels, while nickel is used to improve through-hardening properties and also increase the toughness in the hardened conditions.

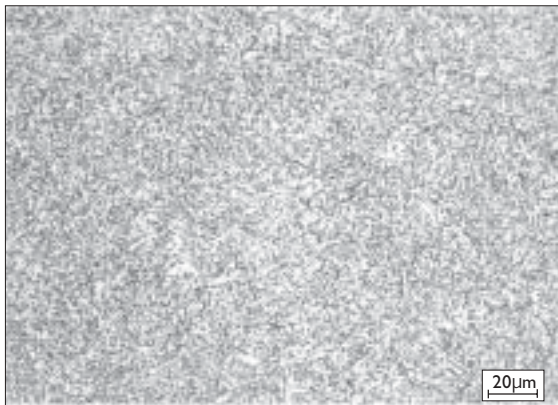

Uddeholm Dievar, soft annealed structure.

Hardening and tempering

When a tool is hardened, many factors influence the result.

Some theoretical aspects

In soft annealed condition, most of the carbide-forming alloying elements are bound up with carbon in carbides.

When the steel is heated up to hardening temperature, the matrix is transformed from ferrite to austenite. This means that the Iron atoms change their position in the atomic lattice and generate a new lattice with different crystallinity.

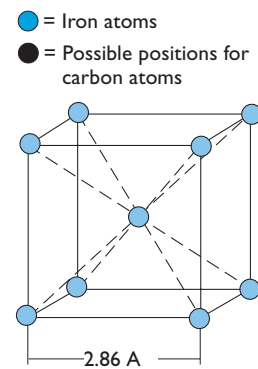

Unit cell in a ferrite crystal.
Body centred cubic (BCC).

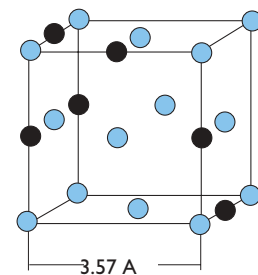

Unit cell in an austenite crystal.
Face centred cubic (FCC).

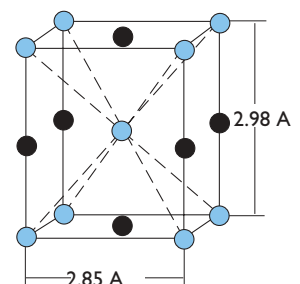

Unit cell in a martensite crystal.
Tetragonal.

Austenite has a higher solubility limit for carbon and alloying elements, and the carbides will dissolve into the matrix to some extent. In this way the matrix acquires an alloying content of carbide-forming elements that gives the hardening effect, without becoming coarse grained.

If the steel is quenched sufficiently rapidly in the hardening process, the carbon atoms do not have the time to reposition themselves to allow the reforming of ferrite from austenite, as in for instance annealing. Instead, they are fixed in positions where they really do not have enough room, and the result is high micro-stresses that contribute to increased hardness. This hard structure is called *martensite*. Thus, martensite can be seen as a forced solution of carbon in ferrite. When the steel is hardened, the matrix is not completely converted into martensite. There is always some austenite that remains in the structure and it is called *retained austenite*. The amount increases with increasing alloying content, higher hardening temperature, longer soaking times and slower quenching.

After quenching, the steel has a microstructure consisting of martensite, retained austenite and carbides. This structure contains inherent stresses that can easily cause cracking. But this can be prevented by reheating the steel to a certain temperature, reducing the stresses and transforming the retained austenite to an extent that depends upon the reheating temperature. This reheating after hardening is called *tempering*. Hardening of tool steel should always be followed immediately by tempering.

It should be noted that tempering at low temperatures only affects the martensite, while tempering at high temperature also affects the retained austenite.

After one tempering at a high temperature the microstructure consists of tempered martensite, newly formed martensite, some retained austenite and carbides.

Precipitated secondary (newly formed) carbides and newly formed martensite can increase hardness during high temperature tempering. Typical of this is the so called secondary hardening of e.g. high speed steels and high alloyed tool steels.

Usually a certain hardness level is required for each individual application of the steel, and therefore heat treatment parameters are chosen to some extent in order to achieve the desired hardness. It is very important to have in mind that hardness is the

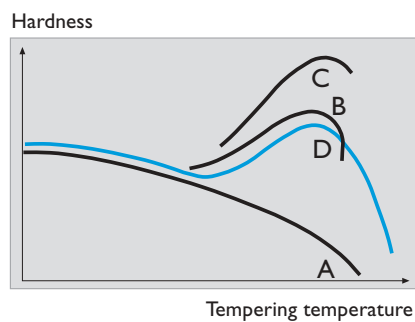

- A = martensite tempering
 B = carbide precipitation
 C = transformation of retained austenite to martensite
 D = tempering diagram for high speed steel and high alloy tool steel
 A+B+C = D

The diagram shows the influence of different factors on the secondary hardening.

result of several different factors, such as the amount of carbon in the martensitic matrix, the micro-stresses contained in the material, the amount of retained austenite and the precipitated carbides during tempering.

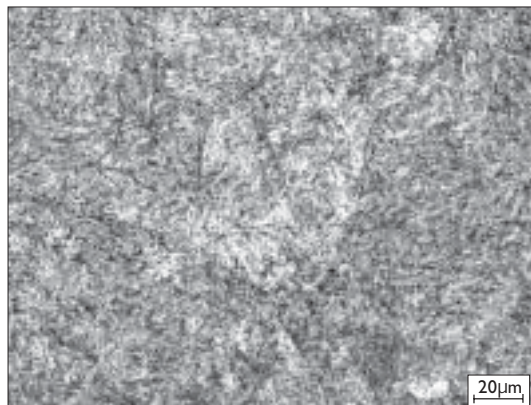

Uddeholm Dievar, hardened structure.

It is possible to make use of different combinations of these factors that will result in the same hardness level. Each of these combinations corresponds to a different heat treatment cycle, but certain hardness does not guarantee any specific set of properties of the material. The material properties are determined by its microstructure and this depends on the heat treatment cycle, and not on the obtained hardness.

Quality heat treatment delivers not only desired hardness but also optimized properties of the material for the chosen application.

Tool steels should always be at least double tempered. The second tempering takes care of the newly formed martensite during cooling after the first tempering.

Three temperings are recommended in the following cases:

- high speed steel with high carbon content
- complex hot work tools, especially in the case of die casting dies
- big moulds for plastic applications
- when high dimension stability is a demand (such as in the case of gauges or tools for integrated circuits)

Stress relieving

Distortion due to hardening must be taken into account when a tool is rough machined. Rough machining causes thermal and mechanical stresses that will remain embedded in the material. This might not be significant on a symmetrical part of simple design, but can be of great importance in an asymmetrical and complex machining, for example of one half of a die casting die. Here, stress-relieving heat treatment is always recommended.

This treatment is done after rough machining and before hardening and entails heating to 550–700°C (1020–1300°F). The material should be heated until it has achieved a uniform temperature all the way through, where it remains 2–3 hours and then cooled slowly, for example in a furnace. The reason for a necessary slow cooling is to avoid new stresses of thermal origin in the stress-free material.

The idea behind stress relieving is that the yield strength of the material at elevated temperatures is so low that the material cannot resist the stresses contained in it. The yield strength is exceeded and these stresses are released, resulting in a greater or lesser degree of plastic deformation.

The excuse that stress relieving takes too much time is hardly valid when the potential consequences are considered. Rectifying a part during semi-finish machining is with few

exceptions cheaper than making dimensional adjustments during finish machining of a hardened tool.

The correct work sequence before hardening operation is: rough machining, stress relieving and semi-finish machining.

Heating to hardening temperature

As has already been explained, stresses contained in the material will produce distortion during heat treatment. For this reason, thermal stresses during heating should be avoided.

The fundamental rule for heating to hardening temperature is therefore, that it should take place slowly, increasing just a few degrees per minute. In every heat treatment, the heating process is named *ramping*. The ramping for hardening should be made in different steps, stopping the process at intermediate temperatures, commonly named *preheating steps*. The reason for this is to equalise the temperatures between the surface and the centre of the part. Typically chosen preheating temperatures are 600–650°C (1100–1200°F) and 800–850°C (1450–1560°F).

In the case of big tools with complex geometry a third preheating step close to the fully austenitic region is recommended.

Holding time at hardening temperature

It is not possible to briefly state exact recommendations to cover all heating situations.

Factors such as furnace type, hardening temperature, the weight of the charge in relation to the size of the furnace, the geometry of the different parts in the charge, etc., must be taken into consideration in each case.

The use of thermocouples permits an overview of the temperature in the different areas of the various tools in the charge.

The ramping step finishes when the core of the parts in the furnace reach the chosen temperature. Then the temperature is maintained constant for a certain amount of time. This is called *holding time*.

The generally recommended holding time is 30 minutes. In the case of high speed steel, the holding time will be shorter when the hardening temperature is over 1100°C (2000°F). If the holding time is prolonged, microstructural problems like grain growth can arise.

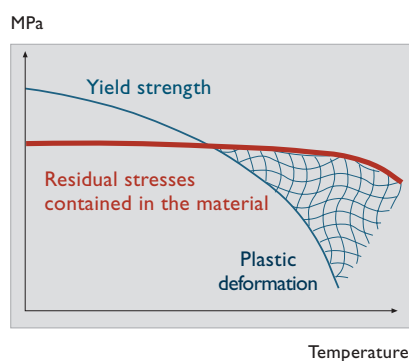

The use of thermocouples gives an overview of the temperature in different areas during heat treatment. Photo: Böhler Uddeholm Czech Republic

Quenching

The choice between a fast and a slow quenching rate is usually a compromise. To get the best microstructure and tool performance the quenching rate should be rapid. To minimize distortion, a slow quenching rate is recommended.

Slow quenching results in less temperature difference between the surface and the core of a part, and sections of different thickness will have a more uniform cooling rate.

This is of great importance when quenching through the martensite range, below the M_s temperature. Martensite formation leads to an increase in volume and stresses in the material. This is also the reason why quenching should be interrupted before room temperature has been reached, normally at $50\text{--}70^\circ\text{C}$ ($120\text{--}160^\circ\text{F}$).

However, if the quenching rate is too slow, especially with heavier cross-sections, undesirable transformations in the microstructure can take place, risking a poor tool performance.

Quenching media used for alloyed steel nowadays are: hardening oil, polymer solutions, air and inert gas.



Batch prepared for heat treatment.
Photo: Böhler Uddeholm Czech Republic.

It is still possible to find some heat treatment shops that use salt baths, but this technique is disappearing due to environmental aspects.

Oil and polymer solutions are usually utilised for low alloyed steel and for tool steel with low carbon contents.

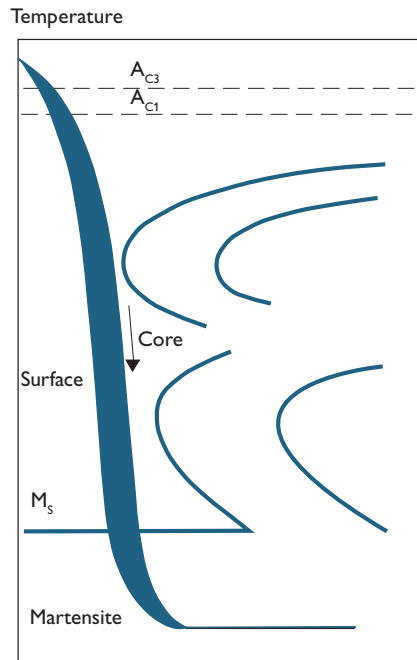

The quenching process as expressed in a CCT graph.

Air hardening is reserved for steel with high hardenability, which in most of the cases is due to the combined presence of manganese, chrome and molybdenum.

Risk of distortion and hardening cracks can be reduced by means of step quenching or martempering. In this process the material is quenched

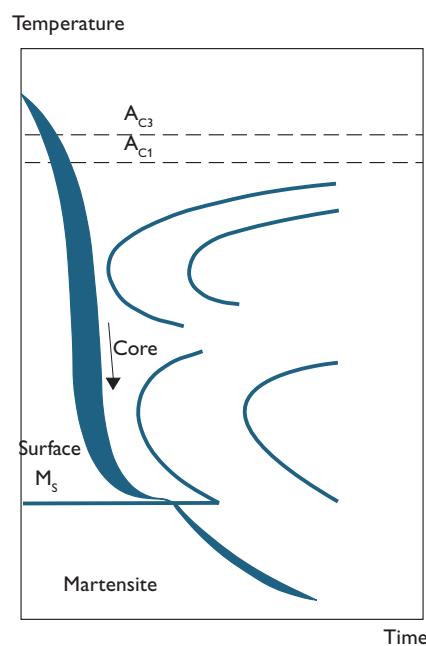

Martempering or step-quenching.

in two steps. First it is cooled from the hardening temperature until the temperature at the surface is just above the M_s temperature. Then it must be held there until the temperature has been equalised between the surface and the core. After this, the cooling process continues. This method permits the core and the surface to transform into martensite at more or less the same time and diminishes thermal stresses. Step quenching is also a possibility when quenching in vacuum furnaces. The maximum cooling rate that can be obtained in a part depends on the heat conductivity of the steel, the cooling capacity of the quenching media and the cross-section of the part.

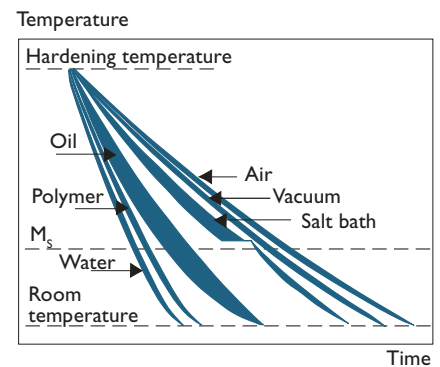

Cooling rates for various media.

A poor quenching rate will lead to carbide precipitation at the grain boundaries in the core of the part, and this is very detrimental to the mechanical properties of the steel. Also the obtained hardness at the surface of larger parts could be lower for tools with bigger cross-sections than that for smaller parts, as the high amount of heat that has to be transported from the core through the surface produces a self-tempering effect.

SOME PRACTICAL ISSUES

At high temperature, steel is very likely to suffer oxidation and variations in the carbon content (carburization or decarburization). Protected atmospheres and vacuum technology are the answer to these problems.

Decarburization results in low surface hardness and a risk of cracking.

Carburization, on the other hand, can result in two different problems:

- the first and easiest to identify is the formation of a harder surface layer, which can have negative effects
- the second possible problem is retained austenite at the surface

Retained austenite can in many cases be confused with ferrite when observing it through the optical microscope. These two phases also have similar hardness, and therefore, what at first sight can be identified as a decarburization can in some cases be



Batch type furnace with controlled atmosphere. Photo: Bodycote Stockholm, Sweden.

the completely opposite problem. For these reasons it is very important that the atmosphere in which the heat treatment takes place does not affect the carbon content of the part.

Wrapping in a hermetically closed stainless-steel foil also provides some protection when heating in a muffle furnace. The steel foil should be removed before quenching.

VACUUM TECHNOLOGY

Vacuum technology is the most used technology nowadays for hardening of high alloyed steel.

Vacuum heat treatment is a clean process, so the parts do not need to be cleaned afterwards. It also offers a reliable process control with high automation, low maintenance and environmental friendliness. All these factors make vacuum technology especially attractive for high-quality parts.

- When the furnace reaches a temperature of approx. 850°C (1560°F), the effect of radiation heating mechanisms will overshadow that of the convection ones in the heat transfer process. Therefore the Nitrogen pressure is lowered, in order to optimize the effects of radiation and convection heating mechanisms are negligible under these new physical conditions. The new value of the nitrogen pressure is around 7 mbar. The reason for having this remaining pressure is to avoid sublimation of the alloying

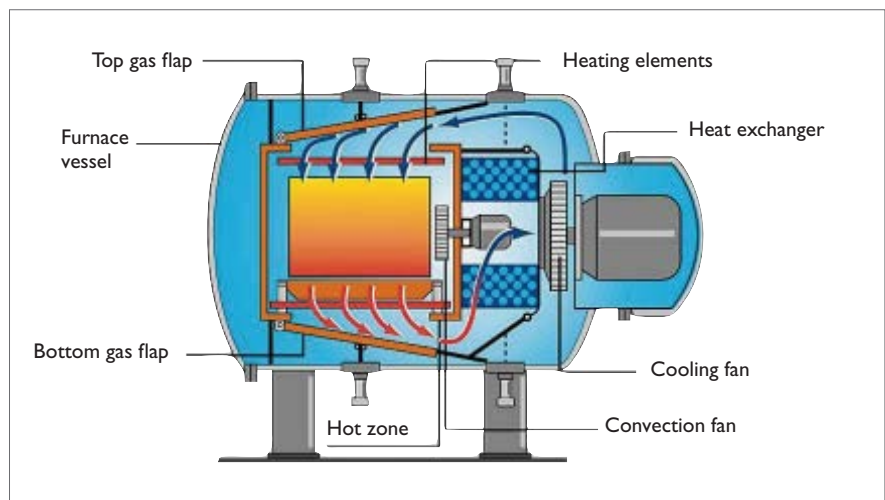

Cooling phase, top cooling. Illustration from Schmetz GmbH Vacuum Furnaces, Germany.

The different steps in the functioning of a vacuum furnace can schematically be listed as follows:

- When the furnace is closed after charging operation, air is pumped out from the heating chamber in order to avoid oxidation.
- An inert gas (most commonly Nitrogen) is injected into the heating chamber until a pressure of around 1–1.5 bar is reached.
- The heating system is started. The presence of the inert gas will make possible the heat transfer process through convection mechanisms. This is the most efficient way to heat up the furnace to a temperature of approx. 850°C (1560°F).

elements, i.e. to avoid the loss of alloying elements to the vacuum. This low pressure condition will be maintained invariant during the last part of the heating process, as well as during the holding time at the chosen hardening temperature.

- The cooling down will be carried out by a massive injection of inert gas (most commonly nitrogen) into the heating chamber in alter-

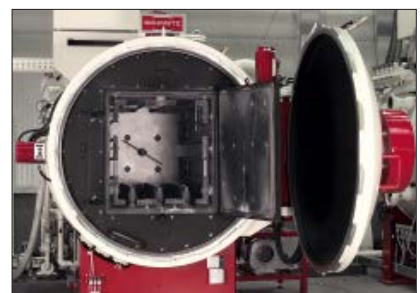

Hot zone with graphite insulation. Photo: Schmetz GmbH Vacuum Furnaces, Germany.

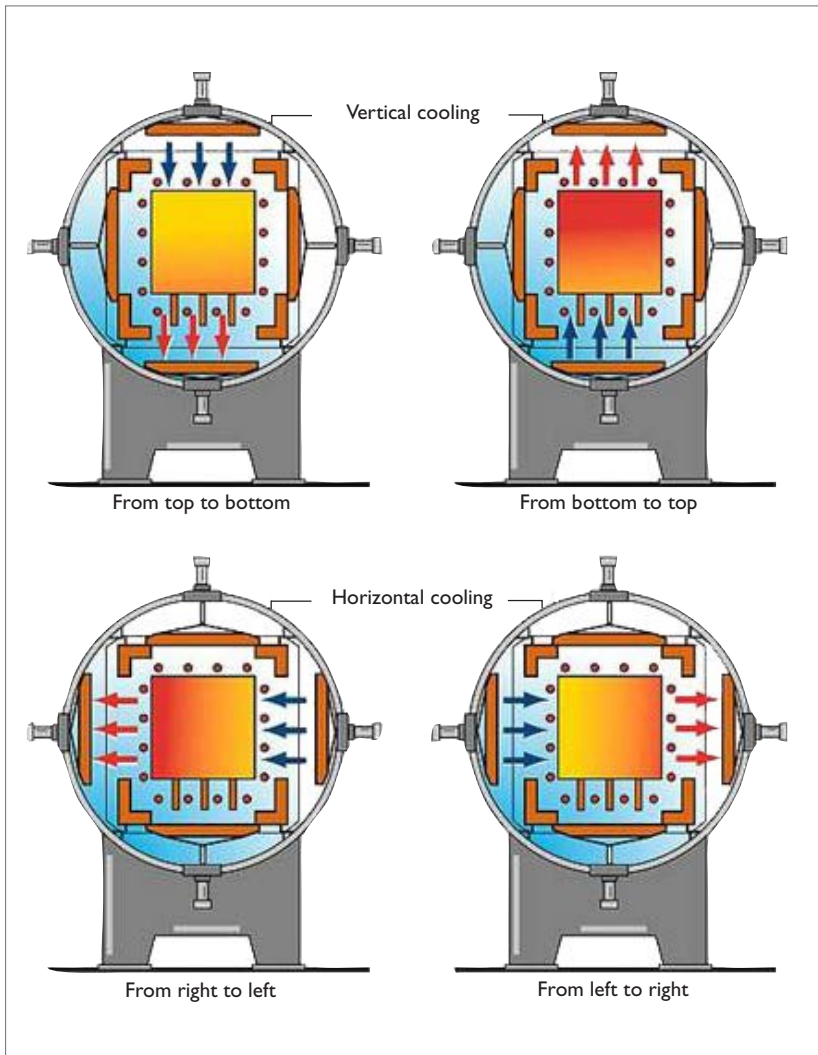

Cooling phase. Nitrogen gas stream passes through the heating chamber in different directions. Illustration from Schmetz GmbH Vacuum Furnaces, Germany.

nating directions and reaching the overpressure that was previously chosen when programming the furnace. The maximum overpressure is a nominal characteristic of each furnace and it gives an idea of its cooling capacity.



Charging operation. Photo: Böhler Uddeholm Czech Republic.

Vacuum furnace. Photo: Schmetz GmbH Vacuum Furnaces, Germany.

Tempering

The material should be tempered immediately after quenching. Quenching should be stopped at a temperature of 50–70°C (120–160°F) and tempering should be done at once. If this is not possible, the material must be kept warm, e.g. in a special “hot cabinet” awaiting tempering.

Please, notice that the stresses contained in the as-quenched material can result in breakage of the crystalline structure and the formation of cracks if the tempering is not done immediately after the quenching process. This breakage of the crystalline structure can take place in a violent way. Therefore the importance of tempering as soon as possible is not only to safeguard the part from cracks, but it is also a matter of personal safety.

Uddeholm has made a wide range of experiments and measurements and collected the resulting data regarding hardness, toughness, dimensional changes and retained austenite in graphs. These graphs are available for the different steel grades and are of great help in order to choose the correct tempering temperature.

The first priority when choosing the tempering temperature should be the mechanical properties, as some small dimensional adjustments can be made in a last fine machining step. The mechanical and physical properties obtained after tempering will depend greatly on the chosen tempering temperature. High-temperature tempering will result in a lower content of retained austenite than low-temperature tempering. The material will therefore have higher compressive strength and improved dimensional stability (in service and at surface coating).

When tempering at high temperature, other differences in properties are also noticeable, like higher heat conductivity.

Precipitation of secondary carbides will occur when tempering highly alloyed steel at a high temperature. This will be detrimental to its corrosion resistance but will give to it somewhat higher wear resistance. If the tool is to be electrical discharge machined (EDM) or coated, high-temperature tempering is necessary.

HOW MANY TEMPERERS ARE REQUIRED?

Two tempers are generally recommended for tool steel, except in the cases of large cross-sections, parts with complex geometries or very high demands on dimensional stability. In these cases, a third tempering is usually needed.

The basic rule of quenching is to interrupt at 50–70°C (120–160°F). Therefore a certain amount of austenite remains untransformed when the material is ready to be tempered. When the material cools after tempering, most of the austenite is transformed to newly formed martensite (untempered). A second tempering gives the material optimum toughness at the chosen hardness level.

HOLDING TIMES IN CONNECTION WITH TEMPERING

Here there is also a general rule, applicable in most of the cases: once the tool has been heated through, hold it for at least two hours at full temperature each time.

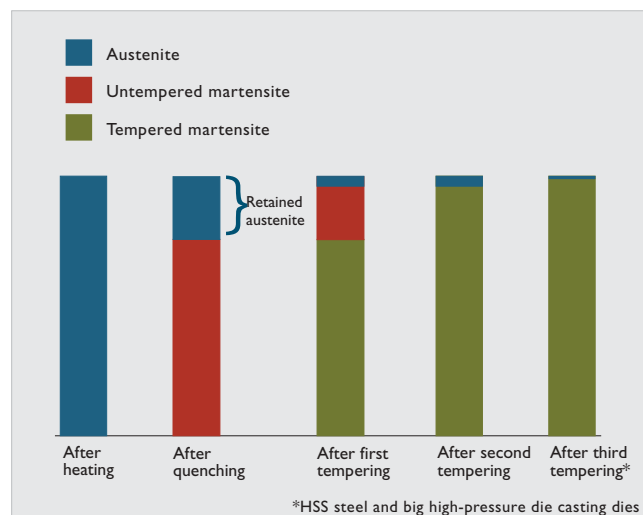

Evolution of the phase content along the different steps of the heat treatment.



A lower die for aluminium rim just before heat treatment on charging grid. Photo: ASSAB Çelik (Turkey)

Dimensional and shape stability

Distortion during hardening and tempering of tool steel

When a piece of tool steel is hardened and tempered, some warpage or distortion normally occurs. This is well known and it is normal practice to leave some machining allowance on the tool prior to hardening, making it possible to adjust the tool to the correct dimensions after hardening and tempering by grinding, for example .

How does distortion take place?

The cause is stresses in the material. These stresses can be divided into:

- machining stresses
- thermal stresses
- transformation stresses

MACHINING STRESSES

Machining stresses are generated during machining operations such as turning, milling and grinding or any type of cold working.

If stresses have built up in a part, they will be released during heating. Heating reduces strength, releasing stresses through local distortion. This can lead to overall distortion.

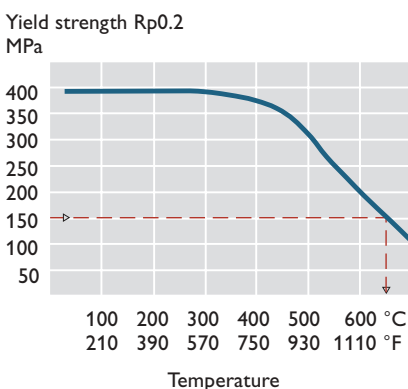

Effect of temperature on the yield strength of Uddeholm Orvar Supreme, soft annealed.

In order to reduce distortion while heating during the hardening process, a stress relieving operation should be carried out prior to the hardening operation. It is recommended to stress relieve the material after rough machining. Any distortion can then be adjusted during semi-finish machining prior to hardening operation.

THERMAL STRESSES

Thermal stresses arise every time there is a temperature gradient in the material, i.e. when the temperature is not even all over the part.

Thermal stresses grow with increasing heating rate. Uneven heating can result in local variations in volume due to uneven dilatation rates and this will also contribute to the arising of stresses and distortion.

In order to tackle this problem, it is common practice to heat up the material in steps, in order to equalise the temperature between the surface and the centre.

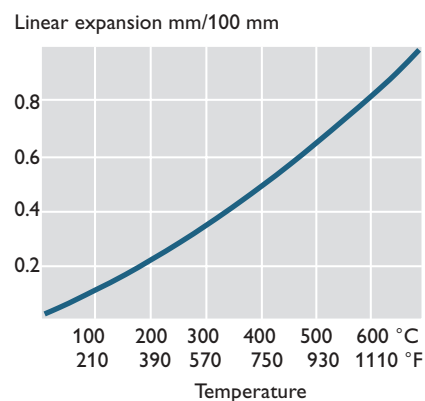

Effect of temperature on the linear expansion of Uddeholm ORVAR Supreme, soft annealed.

An attempt should always be made to heat slowly enough so that the temperature remains virtually equal throughout the piece.

What has been said regarding heating, applies also to cooling. Very powerful stresses arise during quenching. As a general rule, the slower quenching can be done, the less distortion will occur due to

thermal stresses. But as earlier mentioned, a faster quenching will result in better mechanical properties.

It is important that the quenching medium is applied as uniformly as possible. This is especially valid when forced air or protective gas atmosphere (as in vacuum furnaces) is used. Otherwise temperature differences in the tool can lead to significant distortion.

TRANSFORMATION STRESSES

Transformation stresses arise when the microstructure of the steel is transformed. This is because the three phases in question—ferrite, austenite and martensite—have different densities, i.e. volumes.

Out of all the microstructural changes that take place during heat treatment, the biggest contribution to transformation stresses is caused by the transformation of austenite into martensite. This causes a volume increase.

Excessively rapid and uneven quenching can also cause local martensite formation and thereby volume increases locally in a piece and gives rise to stresses in this section. These stresses can lead to distortion and, in some cases, hardening cracks.

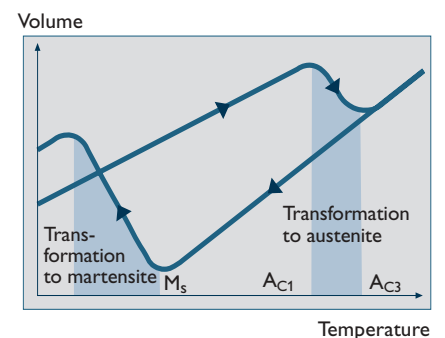

Volume changes due to structural transformation.

How can distortion be reduced?

Distortion can be minimized by:

- keeping the design simple and symmetrical
- eliminating machining stresses by stress relieving after rough machining
- heating up slowly to hardening temperature
- using a suitable grade of steel
- quenching the piece as slowly as possible, but quick enough to obtain a correct microstructure in the steel
- by usage of martempering or step quenching
- tempering at a suitable temperature

The following values for machining allowances can be used as guidelines.

Uddeholm Steel grade	Machining allowance on length and diameter as % of dimension
ARNE	0,25 %
CALDIE	0,25 %
CALMAX/CARMO	0,20 %
CHIPPER/VIKING	0,20 %
RIGOR	0,20 %
SLEIPNER	0,25 %
SVERKER 3	0,20 %
SVERKER 21	0,20 %
VANADIS 4 EXTRA	0,15 %
VANADIS 6	0,15 %
VANADIS 10	0,15 %
VANADIS 23	0,15 %
VANCRON 40	0,20 %
CORRAX	0,05–0,15 %*
ELMAX	0,15 %
MIRRAX ESR	0,20 %
STAVAX ESR	0,15 %
UNIMAX	0,30 %
ALVAR	0,20 %
ALVAR 14	0,20 %
DIEVAR	0,30 %
HOTVAR	0,30 %
ORVAR 2 MICRODIZED	0,20 %
ORVAR SUPREME	0,20 %
QRO 90 SUPREME	0,30 %
VIDAR SUPERIOR	0,25 %
BURE	0,20 %

* Depending on ageing temperature

SUB-ZERO TREATMENT

Retained austenite in a tool can transform into martensite during service. This will lead to local distortion and embrittlement of the tool due to the presence of untempered martensite. Therefore the requirement of maximum dimensional stability in service has an implied demand for very low or no retained austenite content. This can be achieved by using sub-zero treatment after quenching or by high temperature tempering.

The sub-zero treatment leads to a reduction of retained austenite content by exposing the tool or part to very low temperatures. The most commonly used are about -80°C (-110°F) and -196°C (-320°F). This, in turn, will result in a hardness increase of up to 1–2 HRC, in comparison to non sub-zero treated tools, if low temperature tempering is used. For high temperature tempered tools there will be little or no hardness increase.

Tools that are high temperature tempered, even without a sub-zero treatment, will normally have a low retained austenite content and in most cases, a sufficient dimensional stability. However, for high demands on dimensional stability in service it is also recommended to use a sub-zero treatment in combination with high temperature tempering.

For the highest requirements on dimensional stability, sub-zero treatment in liquid nitrogen is recommended after quenching and after

each tempering. Always finish with a tempering as last operation, in order to avoid the existence of untempered martensite in the part.

Surface treatment

Nitriding

Nitriding is performed by exposing the parts to some media rich in nitrogen under certain physical conditions that will result in the diffusion of nitrogen atoms into the steel and the formation of nitrides. The part surface will then be harder and have a higher wear resistance in its outer layer.

In the case of corrosion resistant steel with high-chromium content, it is very important to take into consideration the fact that nitriding has a detrimental effect on the corrosion resistance of the material. In other cases nitriding can have a positive effect on the corrosion resistance.

Appropriate steel to be nitrided are usually medium-carbon steel with nitride-forming elements such as chromium, aluminium, molybdenum and vanadium.

The core should act as a stable substrate regarding mechanical properties and microstructure. This means that for hardened material it is necessary to temper above the nitriding temperature in order to avoid softening of the core during the nitriding process.

It should be noted that a nitrided surface cannot be machined with

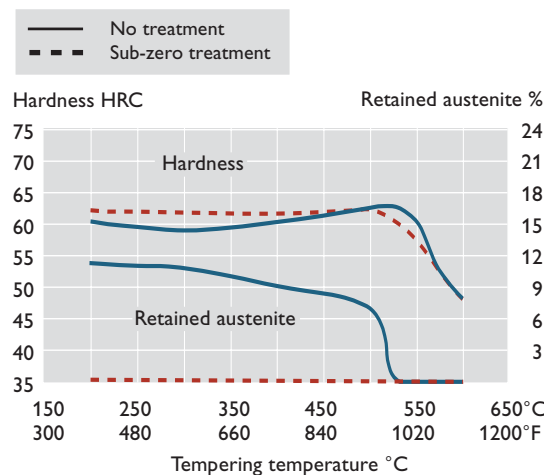

Uddeholm Sleiþner. Hardness and retained austenite as function of tempering temperature with and without sub-zero treatment.

cutting tools and can only be ground with difficulty. A nitrided surface will cause problems in weld repairing as well.

There are several technologies available in the field of nitriding; the main ones are gas nitriding, high pressure nitriding (carried out in vacuum furnaces) and plasma nitriding.

Two common problems of conventional nitriding technologies are possible over-tempering of the substrate material and thickening of the nitrided layer in the sharp corners.

Pulsed plasma nitriding technology diminishes the possibility of over-tempering by applying the plasma intermittently on the part. This provides a better control over the local temperatures during the process. *Active screen plasma nitriding* is also a development of plasma nitriding technology. This technology promises a uniform thickness of the nitride layer independently of its geometry.

Nitrocarburizing

Nitrocarburizing is a process in which the parts are to be enriched in nitrogen and also in carbon, the enrichment is carried out by exposure to atmosphere rich in these two elements. A mixture of ammonia gas and carbon monoxide or dioxide is an example of a suitable atmosphere

for this purpose. The temperature range for this process is 550°C to 580°C (1020°F to 1075°F) and the time of exposure is between 30 minutes and 5 hours.

After the exposure the part should be cooled down rapidly.

Case hardening

Case hardening is a process in which a finished part is exposed to a carburizing atmosphere and high temperature simultaneously. The temperature range is 850°C–950°C (1560°F–1740°F). This exposure generates a layer with higher carbon content, normally 0.1–1.5 mm thick. After the layer has been formed, the part is to be quenched in order for the layer to transform into martensite with higher carbon content, and it will therefore have a higher hardness. Tempering of the part should follow.

Thermal diffusion

Thermal diffusion is a process in which vanadium diffuses into the material and reacts with existing carbon, to form a vanadium carbide layer. The steel must have a minimum of 0.3% carbon. This surface treatment provides a very high level of abrasive wear resistance.

Surface coating

Surface coating of tool steel has become a common practise. The general aim for these kinds of processes is to generate an outer layer with a very high hardness and low friction that results in good wear resistance, minimising the risk for adhesion and sticking. To be able to use these properties in an optimal way a tool steel of high quality should be chosen.

The most commonly used coating methods are:

- **physical vapour deposition coating** (PVD coating)
- **chemical vapour deposition coating** (CVD coating)
Chemical vapour deposition coating can also be carried out with a plasma assisted technology (PACVD)



CVD TiC/TiN. Photo Eifeler Werkzeuge, Germany.

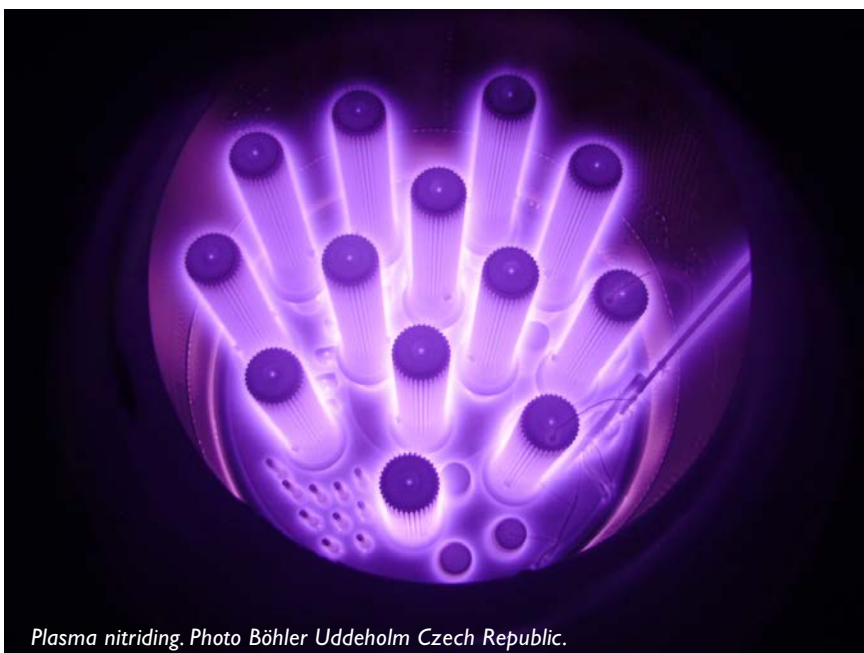

Plasma nitriding. Photo Böhler Uddeholm Czech Republic.

Platings

Chromium and nickel metallic platings are commonly used for a variety of tooling applications, like plastic injection moulds. Platings may be deposited over most steel grades and they will prevent seizing and galling, reduce friction, increase surface hardness and prevent or reduce corrosion of the substrate's surface.

Testing of mechanical properties

When the steel is hardened and tempered, its strength is affected, so let us take a closer look at how these properties are measured.

Hardness testing

Hardness testing is the most popular way to check the results of hardening. Hardness is usually the property that is specified when a tool is hardened.

It is easy to test hardness. The material is not destroyed and the apparatus is relatively inexpensive. The most common methods are Rockwell C (HRC), Vickers (HV) and Brinell (HBW).

The old expression “file-hard” should not be entirely forgotten. In order to check whether hardness is satisfactory, for example above 60 HRC, a file of good quality can provide a good indication.

ROCKWELL (HRC)

This method is suitable for hardened material and never for material in soft annealed condition. In Rockwell hardness testing, a conical diamond is first pressed with a force F_0 , and then with a force F_0+F_1 against a specimen of the material which hardness is to be determined. After unloading to F_0 , the increase (e) of the depth of the impression caused by F_1 is determined. The depth of penetration (e)

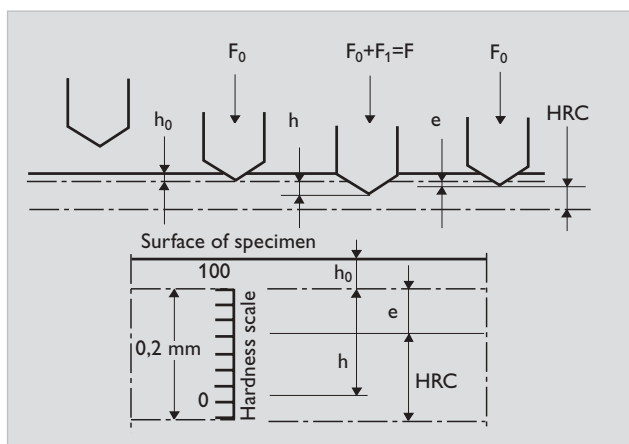

Principle of Rockwell hardness testing.

is converted into a hardness number (HRC) which is read directly from a scale on the tester dial or read-out.

VICKERS (HV)

Vickers is the most universal of the three testing methods. In Vickers hardness testing a pyramid-shaped diamond with a square base and a peak angle of 136° is pressed under a load F against the material whose hardness is to be determined. After unloading, the diagonals d_1 and d_2 of the impression are measured and the hardness number (HV) is read off a table.

When the test results are reported, Vickers hardness is indicated with the letters HV and a suffix indicating the mass that exerted the load and (when required) the loading period, as illustrated by the following example:

$HV\ 30/20$ = Vickers hardness determined with a load of 30 kgf exerted for 20 seconds.

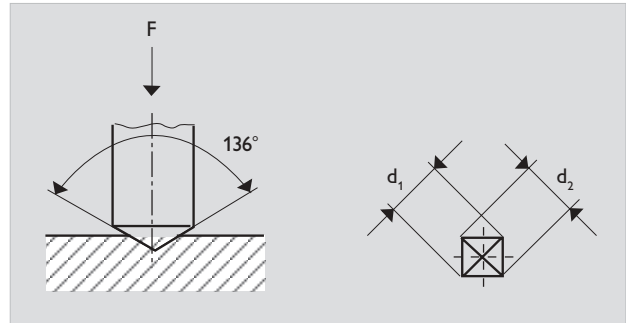

Principle of Vickers hardness testing.

BRINELL (HBW)

This method is suitable for soft annealed condition and prehardened steel with relatively low hardness. In Brinell hardness testing, a tungsten (W) ball is pressed against the material whose hardness is to be determined. After unloading, two measurements of the diameter of the impression are taken at 90° to each other (d_1 and d_2) and the HBW value is read off a table, from the average of d_1 and d_2 .

When the test results are reported, Brinell hardness is indicated with the letters HBW and a suffix indicating ball diameter, the mass with which the load was exerted and (when required) the loading period, as illustrated by the following example: $HBW\ 5/750/15$ = Brinell hardness determined with 5 mm tungsten (W) ball and under load of 750 kgf exerted for 15 seconds.

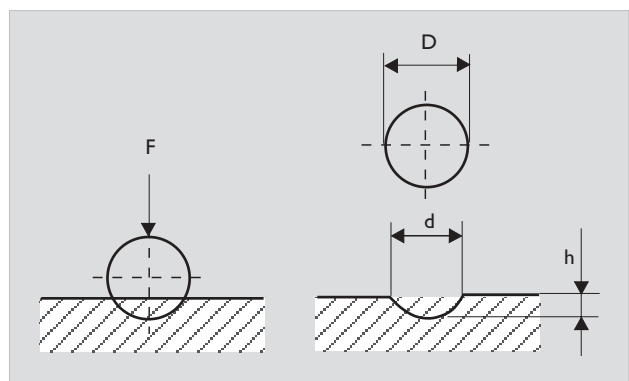

Principle of Brinell hardness testing.

Tensile strength

Tensile strength is determined on a test piece which is gripped in a tensile testing machine and subjected to a successively increasing tensile load until fracture occurs. The properties that are normally recorded are yield strength $R_{p0.2}$ and ultimate tensile strength R_m , while elongation A_5 and reduction of area Z are measured on the test piece. In general, it can be said that hardness is dependent upon yield strength and ultimate tensile strength, while elongation and reduction of area are an indication of toughness. High values for yield and ultimate tensile strength generally mean low values for elongation and reduction of area.



Tensile test.

Tensile tests are used mostly on structural steel, seldom on tool steel. It is difficult to perform tensile tests at hardnesses above 55 HRC. Tensile tests may be of interest for tougher types of tool steel, especially when they are used as high strength structural materials. These include e.g. Uddeholm Impax Supreme and Uddeholm Orvar Supreme.

Impact testing

A certain quantity of energy is required to produce a fracture in a material. This quantity of energy can be used as a measure of the toughness of the material, a higher absorption of energy indicating better toughness. The most common and simplest method of determining toughness is impact testing. A rigid pendulum is allowed to fall from a known height and to strike a test specimen at the lowest point of its swing. The angle through which the pendulum travels after breaking the specimen is measured, and the amount of energy that was absorbed in breaking the specimen can be calculated.

Several variants of impact testing are in use. The various methods differ in the shape of the specimens. These are usually provided with a V- or U-shaped notch, the test methods being then known as Charpy V and Charpy U respectively.

For the most part, tool steel has a rather low toughness by reason of its high strength. Materials of low toughness are notch sensitive, for which reason smooth, unnotched specimens are often used in the impact testing of tool steel. The results of the tests are commonly stated in joules, or alternatively in kgm (strictly speaking kgfm), although J/cm^2 or kgm/cm^2 is sometimes used instead, specially in Charpy U testing.



Impact testing machine.

Some words of advice to tool designers

Design

Avoid:

- sharp corners
- notch effects
- large differences in section thicknesses

These are often causes of hardening cracks, especially if the material is cooled down too far or allowed to stand untempered.

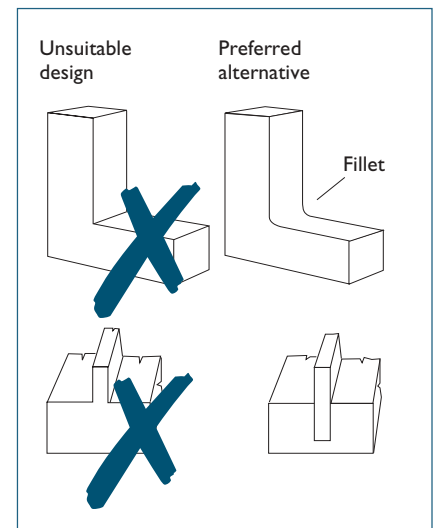

Heat treatment

Choose suitable hardnesses for the application concerned. Be particularly careful to avoid temperature ranges that can reduce toughness after tempering.

Keep the risk of distortion in mind and follow recommendations concerning machining allowances.

It is a good idea to specify stress relieving on the drawings.



Vacuum furnace.

Approx. hardness after hardening and tempering

Uddeholm grade	Austenitizing temperature °C	HRC at tempering temperature °C, 2 x 2 h					
		200	250	500	525	550	600
ALVAR 14	850 ¹⁾	54	53	45	–	42	38
ALVAR	900	54	53	45	–	43	41
ARNE	830 ¹⁾	62	60	45	43	41	38
BURE	1020	52	52	53*	–	52	46
CALDIE	1020	–	–	–	61***	59	50
CALMAX	960	59	58	53	53	50	43
CARMO	960	59	58	53	53	50	43
CHIPPER	1010	59	57	59*	58	56	48
CORRAX	850 ²⁾	–	–	–	–	–	–
DIEVAR	1025	53	52	52*	–	52	47
ELMAX ³⁾	1080	59	58	60**	59**	58**	–
FERMO	–	Delivered in prehardened condition					
FORMAX	–	Delivered in prehardened condition					
HOLDAX	–	Delivered in prehardened condition					
HOTVAR	1050	–	56	–	–	57	53
IMPAX	–	Delivered in prehardened condition					
SUPREME	–	Delivered in prehardened condition					
MIRRAX ESR	1020	–	50	52**	–	42**	36
MIRRAX 40	–	Delivered in prehardened condition					
NIMAX ⁴⁾	–	Delivered in prehardened condition					
ORVAR	–	Delivered in prehardened condition					
SUPREME	1020	52	52	54*	–	52	46
ORVAR	–	Delivered in prehardened condition					
SUPERIOR	1020	52	52	54*	–	52	46
ORVAR 2	–	Delivered in prehardened condition					
MICRODIZED	1020	52	52	54*	–	52	46
POLMAX	1030	53	52	54**	–	53**	37
QRO 90	–	Delivered in prehardened condition					
SUPREME	1020	49	49	51*	–	51*	50 ⁵⁾
RAMAX HH	–	Delivered in prehardened condition					
ROYALLOY	–	Delivered in prehardened condition					
RIGOR	950	61	59	56*	55*	53	46
SLEIPNER	1030	60	59	–	62***	60	48
SR 1855	850	63	62	50	48	46	42
STAVAX ESR	1030	53	52	54***	–	43***	37
SVERKER 3	960	60	59	56	53	–	–
SVERKER 21	1020	63	59	60	57	54	48
UHB 11	–	As-delivered condition (~200HB)					
UNIMAX	1020	–	–	–	–	55	49
VANADIS 4	–	Delivered in prehardened condition					
EXTRA ³⁾	1020	–	59	–	61***	60	52
VANADIS 6 ³⁾	1050	63	62	–	62***	59	52
VANADIS 10 ³⁾	1060	63	62	–	62***	60	52
VANCRON 40 ³⁾	950–1100	3 x 560 °C 57–65					
VIDAR	–	Delivered in prehardened condition					
SUPERIOR	1000	52	51	51*	–	50	45
VIDAR 1	1000	54	53	55*	–	52	46
VIDAR 1 ESR	1000	54	53	55*	–	52	46
High speed steel		3 x 560 °C					
VANADIS 23 ³⁾	1050–1180	60–66					
VANADIS 30 ³⁾	1000–1180	60–67					
VANADIS 60 ³⁾	1000–1180	64–69					

* This tempering temp. should be avoided due to the risk of temper brittleness.

** For Uddeholm Stavax ESR, Uddeholm Mirrax SER, Uddeholm Polmax and Uddeholm Elmax corrosion resistance is reduced.

*** The lowest tempering temperature when high temperature tempering is 525 °C.

¹⁾ Quench in oil

²⁾ Solution treatment. Ageing: ~50 HRC after 525 °C/2 h, ~46 HRC after 575 °C/2h, ~40 HRC after 600 °C/4h.

³⁾ Powder Metallurgy tool steel

⁴⁾ The delivery hardness of Uddeholm Nimax can not be increased. Tempering shall be avoided as toughness will be reduced.

⁵⁾ At 650 °C 2 x 2h: 42 HRC

Hardness conversion table

Approx. comparison between hardness and ultimate tensile strength.

Rockwell		Brinell*	Vickers 30 kg	Approx. UTS	
HRC	HRB			N/mm ²	kp/mm ²
	78	133	140	446	46
	85	152	160	510	52
	91	171	180	570	58
	95	190	200	637	65
	98	209	220	696	71
		228	240	756	77
		247	260	824	84
		265	280	883	90
30		284	300	951	97
33		303	320	1020	104
35		322	340	1080	110
37		341	360	1150	117
39		360	380	1210	123
41		379	400	1280	130
42		397	420	1340	137
44		415	440	1410	144
46		433	460	1470	150
47		452	480	1530	156
48		471	500	1610	164
50		488	520	1690	172
51		507	540	1770	180
52		525	560	1850	188
53		545	580	1940	198
54		564	600		
55		584	620		
56		601	640		
57		620	660		
59		638	680		
59			700		
60			720		
61			740		
62			760		
63			780		
64			800		
64			820		
65			840		
66			860		
66			880		

* 10 mm ball, 3 000 kg load.



Network of excellence

Uddeholm is present on every continent. This ensures you high-quality Swedish tool steel and local support wherever you are. Assab is our exclusive sales channel, representing Uddeholm in the Asia Pacific area. Together we secure our position as the world's leading supplier of tooling materials.

UDDEHOLM is the world's leading supplier of tooling materials. This is a position we have reached by improving our customers' everyday business. Long tradition combined with research and product development equips Uddeholm to solve any tooling problem that may arise. It is a challenging process, but the goal is clear – to be your number one partner and tool steel provider.

Our presence on every continent guarantees you the same high quality wherever you are. ASSAB is our exclusive sales channel, representing Uddeholm in the Asia Pacific area. Together we secure our position as the world's leading supplier of tooling materials. We act worldwide, so there is always an Uddeholm or ASSAB representative close at hand to give local advice and support. For us it is all a matter of trust – in long-term partnerships as well as in developing new products. Trust is something you earn, every day.

For more information, please visit www.uddeholm.com, www.assab.com or your local website.

UD
WOR
RUST IS SOM
TRUST IS I
AUTOM
KINDING SU
TOUGHNESS STR
MATERIALS H
EDDING WATER
BYSTANDIN
RESULTS. M
CUSTOMER B
BILITY TRUST IS
AUTOMOTIVE
LEADING SU
INNOVATION
STRENGTH INNOVATION
WORLDWIDE PRE
SOMETHING YO
PROBLEM
THE WORL
NOMY THE
DUCTILITY TO
COMMITMENT PART
KNOWLEDGE UN
KNOWLEDGE
RELIAB
OF EXCEL
AUTOMOTIVE A
ECONOMY THE
TOTAL ECONOMY
DUCTILITY TOUGHNE
HARDNESS WORLDW
TRUST IS SOMETH
UNDERSTANDING MACHIN
RESULTS SOLVING PROB
ECONOMY THE WORL
STRENGTH IN
TOUGHNESS STRENGTH I
MATERIALS PARTN
UNDERSTANDING MACHIN
BILITY RELIABILITY RESU
LASTING TOOLS TOTAL
YOU EARN, EVERY DAY. LO
OF THINKING HIGH PE
OFTOOLING MATERIALS C
INNOVATION KNOWLEDGE
STRENGTH INNOVATION KNOW
REFERENCE LONG DURABILITY
TRUST IS SOMETHING YOU EARN,
PROBLEMS AUTOMOTIVE