

Setting new global standards

Uddeholm Dievar

**PUSHING PERFORMANCE
TO NEW LIMITS**



 **UDDEHOLM**
a voestalpine company

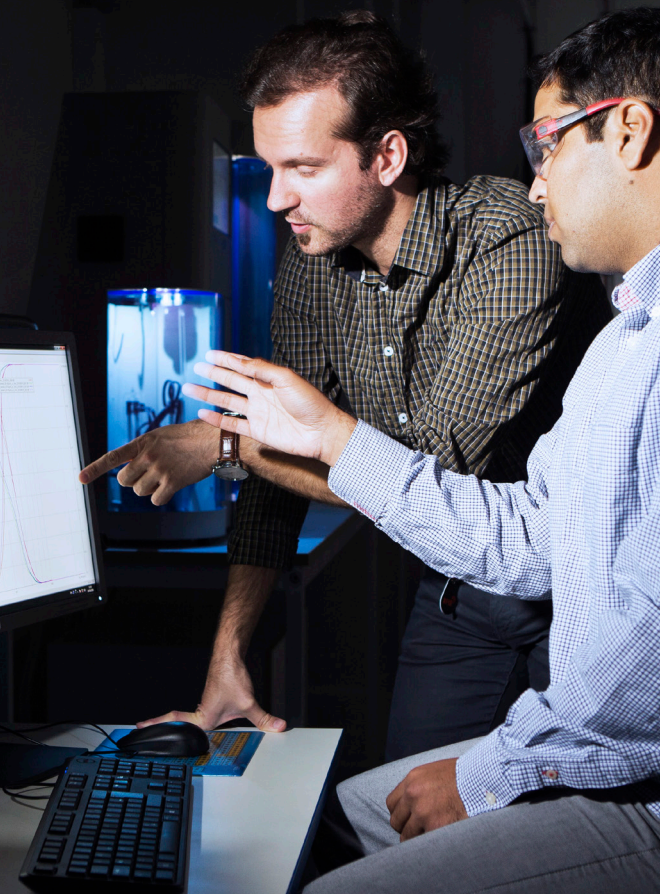

Uddeholm is the world leader in the development and production of premium tool steel for the manufacturing industry.



THE BEST JUST GOT BETTER

SETTING NEW GLOBAL STANDARDS

The most demanding production projects will get access to a new level of performance against heat checking and cracking.

A NEW LEVEL OF PERFORMANCE

Uddeholm presents a new solution for common problems and future challenges, with a new level of toughness. The previous premium level of delivered toughness was a minimum average of

19 Joules. Today Uddeholm Dievar sets a new global standard of 25 Joules. Market leading metallurgy and production techniques has enabled an outstanding upgrade in performance.

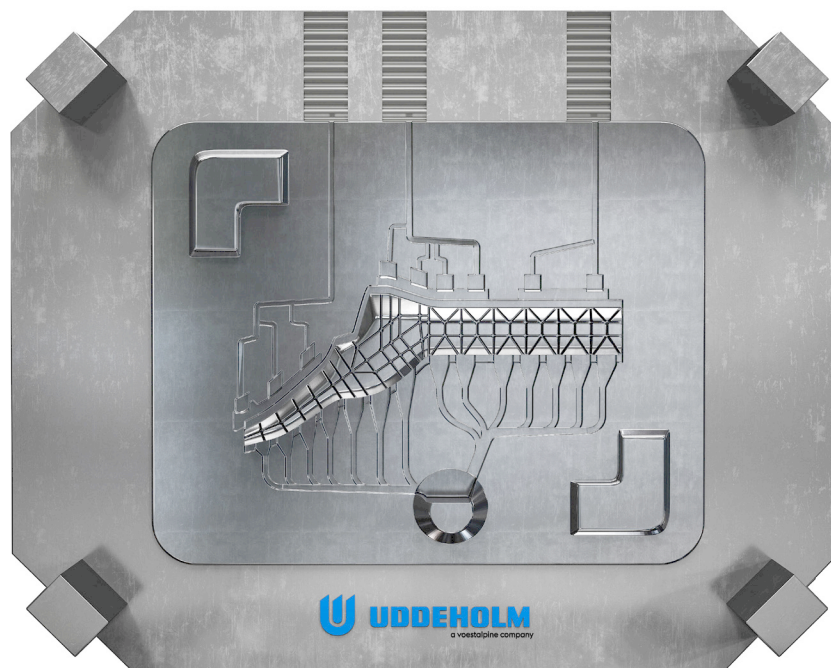
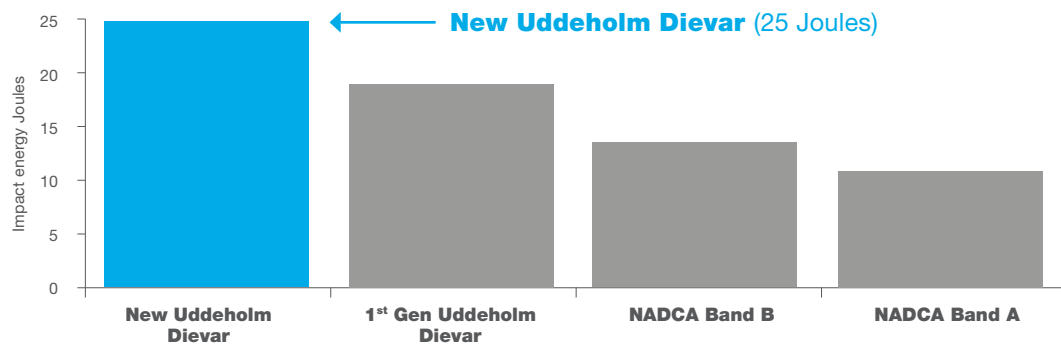

A UNIQUE GRADE WITH VALUABLE PROPERTIES

RELIABLE AND CONSISTANT PRODUCTION

Uddeholm Dievar can help make your tools more reliable and consistent in production. The most common repair of HPDC tooling is heat checking damage.

WHAT HAPPENS WITH HIGHER HRC?

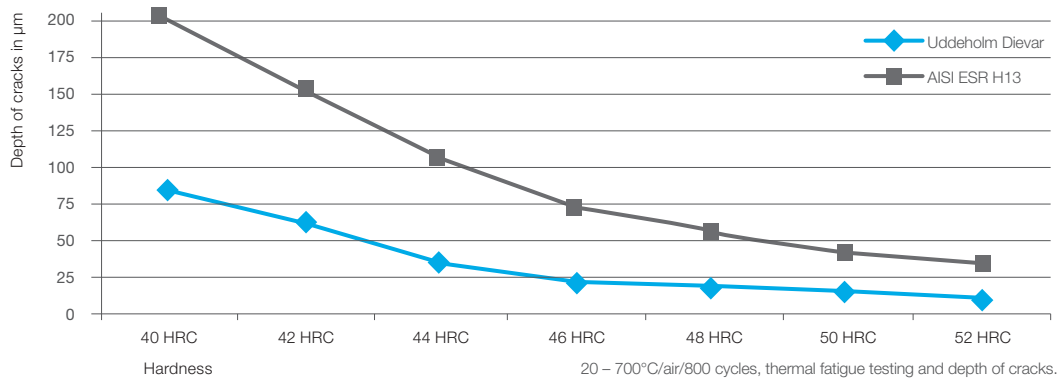

TOUGHNESS AT DIFFERENT HARDNESS LEVELS

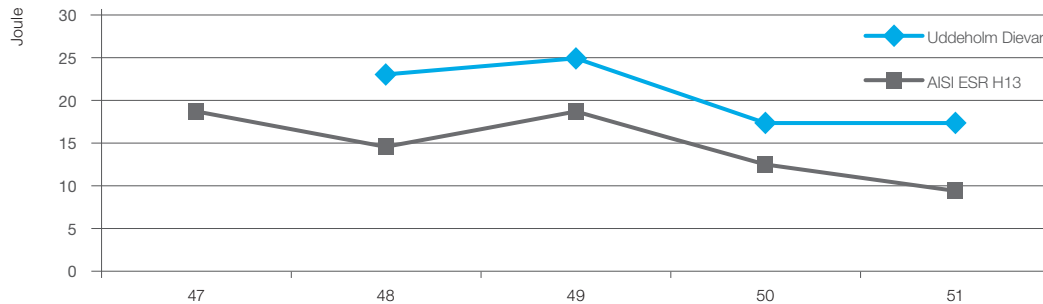

DESIGNED TO DELAY HEAT CHECKING

To prevent the initiation and propagation of heat check cracks you need high ductility and high toughness. These properties are a direct effect of the chemistry and the development process of Uddeholm Dievar over recent years.

Uddeholm Dievar's outstanding heat checking resistance over AISI ESR H13 can be seen in the chart from 40HRC up to 52HRC. Uddeholm Dievar's properties yields the highest possible level of heat checking resistance in order to

reduce the life time costs of the die. It is a known fact that higher hardness delays heat checking, but the risk of cracking in the tool increases. Uddeholm Dievar has been internally tested at higher hardness ranges to show how it performs.

As tested, Uddeholm Dievar was excellent in every hardness range to AISI ESR H13. Now you can have the best of both worlds, high heat checking resistance combined with new levels of toughness to help you get the best performance from your dies.

IMPROVED DIE ECONOMY

STRENGTH AND SUPPORT FOR ALL SIZES

Longer die life and reliable production are possible when using Uddeholm Dievar.

ANSWERS TO TODAY'S CHALLENGES

Due to the growth in large structural automotive parts and other e-mobility parts, we see dies expanding in size and tooling becoming more complex. New aluminium types, higher melting temperatures and dies with more

gates than a traditional part are all pointing to lower die life with heat checking as the major cause when compared to traditional cast parts. This battery box example shows where die life can be very low.

Typical battery box min and max production values from customer feedback. These customers are now so confident using Uddeholm Dievar they guarantee the die life to their end user.

Die Type	Die Steel	*Min/Max shots
Large Battery box	AISI ESR H13	<40K - 60K
Large Battery box	Dievar	80 - 100K

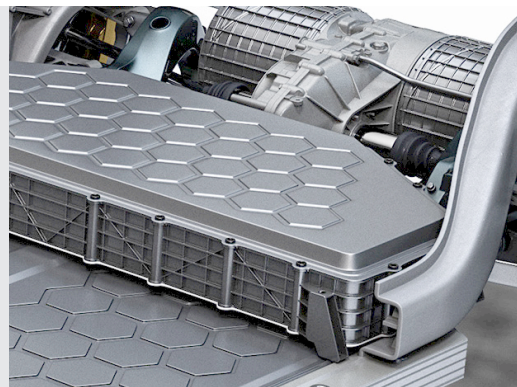

Using Uddeholm Dievar over AISI ESR H13/H11 can have serious financial benefits. It has proven itself superior to AISI ESR H13/H11 for heat checking damage, which can potentially save

lots of lost value in production volumes. The cost per part, press productivity and a reduction in the overall tooling cost can be achieved as the following customer case shows.

Steel grade:	H13	Dievar
A. Tool steel cost (€)	7 000	14000
B. Tool making cost (€) (soft machining, HT, hard machining, polishing, adjusting etc)	6 100	6 300
C. Total tool cost (€), (A+B)	13 100	20 300
D. No. of parts/tool (tool life)	5 000	50 000
E. Total tool cost/part during tool life (€)	2.62	0.41
F. Production (Number of parts)	50 000	
G. Total tool cost/part during F (€)	2.62	0.41

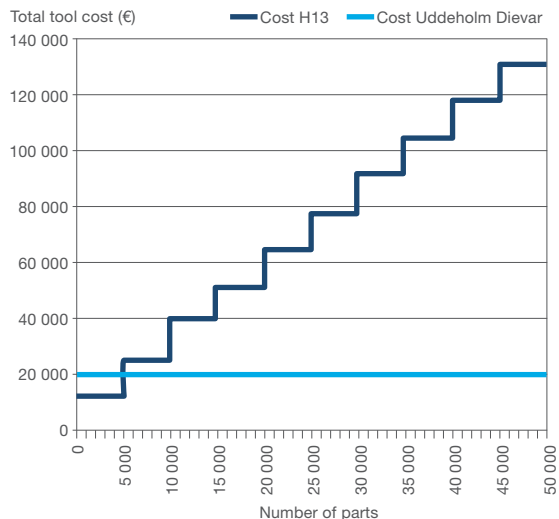

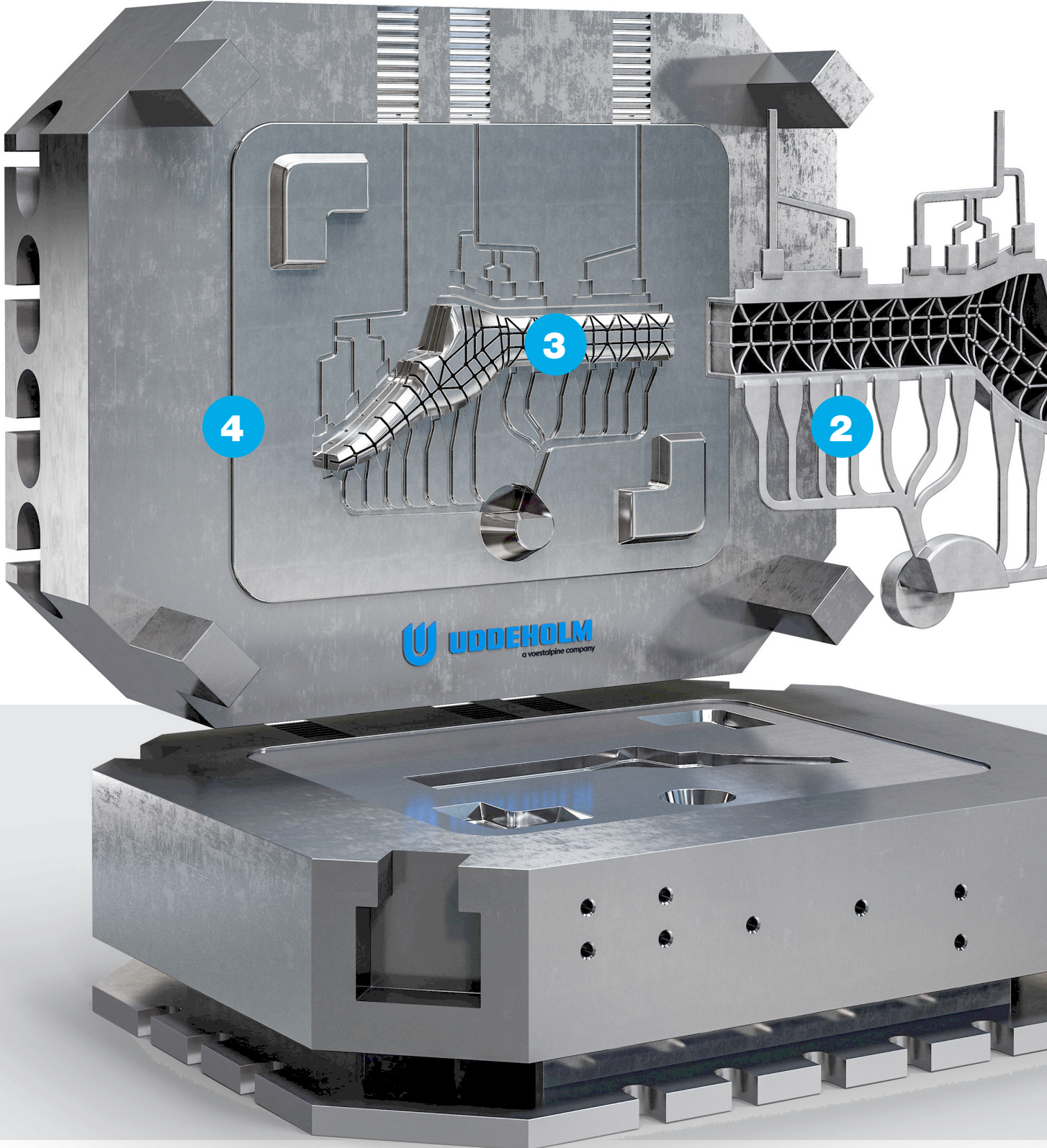



UDDEHOLM DIEVAR – FOR THE MOST DEMANDING OF APPLICATIONS

ADVANCED TECHNOLOGY NEEDS NEW SOLUTIONS

Uddeholm Dievar will push you a step further in preparation for coming trends. Due to the growth in large structural automotive parts, the risk of cracking, heat checking and unexpected expensive maintenance stops are common problems today. Uddeholm Dievar is the steel you need to remain profitable in an innovative automotive industry.

KEEP PRODUCTION RUNNING

To keep costs down in the long run, you need a tool steel solution that not only can

handle the most demanding designs and cooling cycles, but also can push you a step further in preparation for coming trends.



1 RUNNERS

Dies which run on higher injection speeds demand a tool steel with excellent erosion resistance, temper-back resistance, hot strength, creep strength and weldability for ease of repair.

2 MULTIPLE GATES

Larger dies with multiple gates need excellent erosion resistance, temper-back resistance, thermal fatigue resistance and weldability.

3 COMPLEX DESIGN

Demanding modern designs push inserts and die blocks too the limits. Excellent toughness and ductility are critically important to get maximum die life.

4 LARGE INSERTS AND DIES

Large parts need large inserts and dies, which require the best toughness possible in combination with excellent heat checking resistance, hardenability and weldability.

BE PREPARED FOR THE NEW TRENDS

DEVELOPED FOR E-MOBILITY

Keep your productivity rates up by using Uddeholm Dievar.

READY FOR THE FUTURE

The complex geometries and quality requirements of new e-mobility parts are pushing die life demands to new levels.

Covering the whole HPDC package, Uddeholm Dievar has the answer to long production volumes in these challenging new parts.

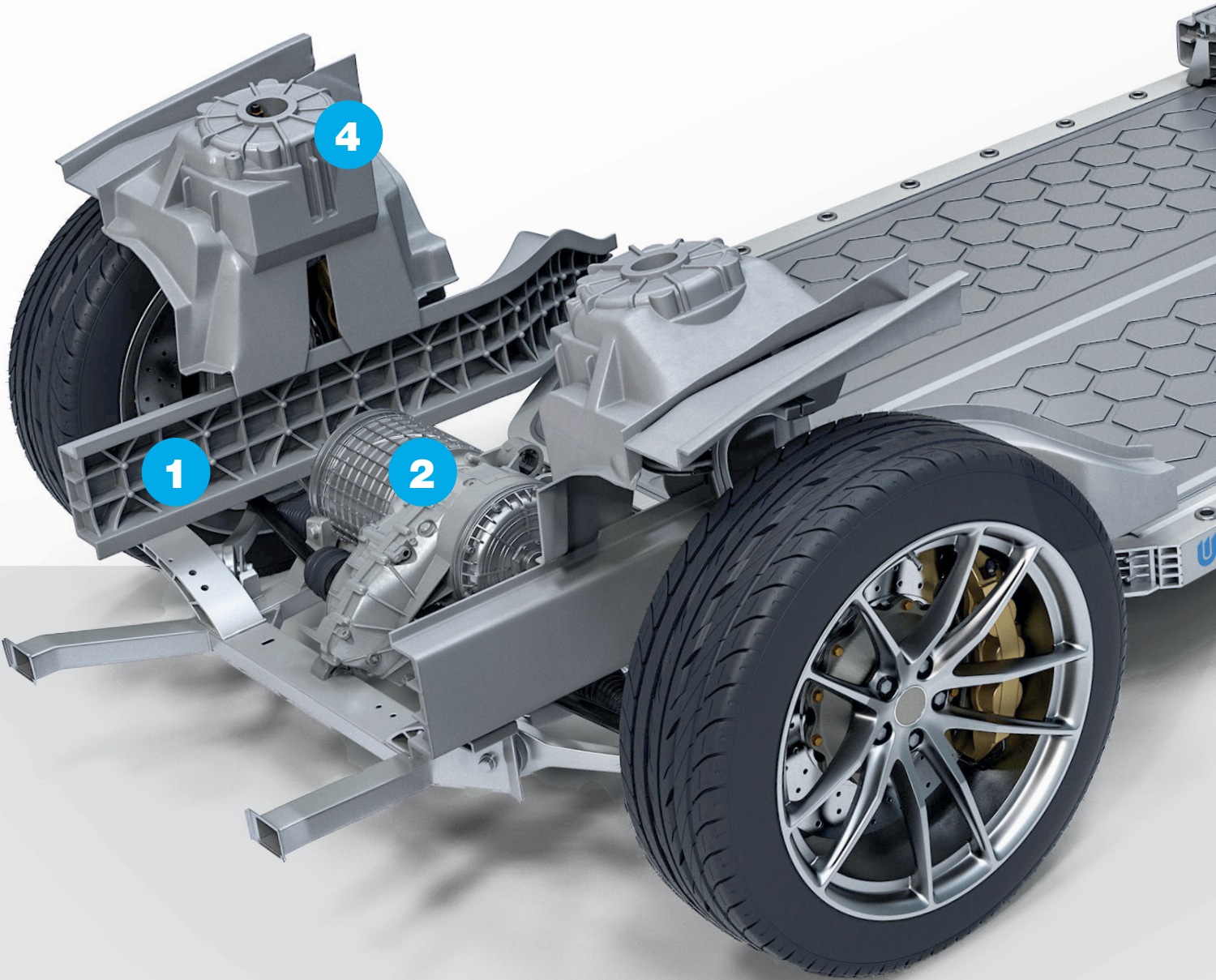



Uddeholm Dievar in short

- More quality parts for all size ranges
- Lower cost production
- Longer tool life
- Excellent heat checking resistance
- Best toughness in its class

1 STRUCTURAL PARTS

These parts have large surface areas with thin and thick sections and demand a high quality surface finish. Parts cannot have heat checking damage on them but this is a challenge due to the multiple gate designs.

2 ELECTRIC MOTOR HOUSINGS

Large cast parts with high demands on quality can suffer from heat check damage, erosion and soldering in complex section areas.

3 BATTERY PACKS AND BOXES

Battery packs can be very large and the weight means lots of heat into the tool. Heat checking damage is often not allowed on the outside faces and die life can be low compared to a traditional cast part.

4 REDUCED PRODUCTION

Feedback from customers shows that these new part types are running much lower volumes than expected because of high heat checking damage levels. Typical examples are shock tower dies where the goal would be +60K. However, some report under 30K in AISI ESR H13/H11 dies.

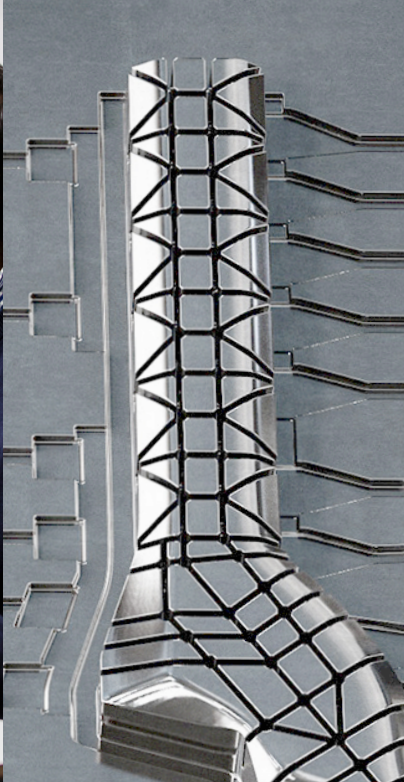

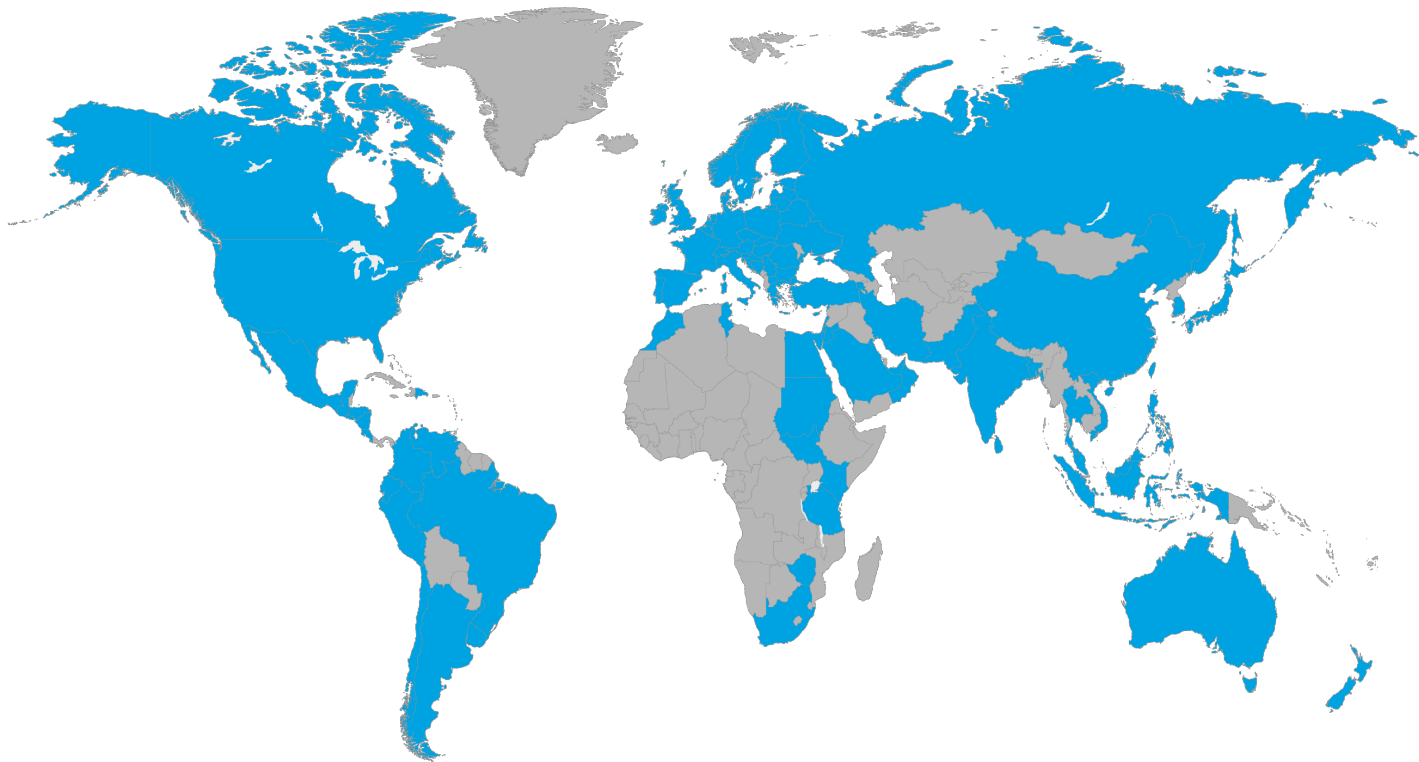

NETWORK OF EXCELLENCE

Uddeholm is present on every continent. This ensures you high-quality Swedish tool steel and local support wherever you are. We secure our position as the world's leading supplier of tooling materials.

For more information, visit our website at uddeholm.com



SS-EN ISO 9001
SS-EN ISO 14001

Manufacturing solutions for generations to come

SHAPING THE WORLD

Since 1668 we have been providing a wide range of innovative cutting-edge solutions for our customers in demanding segments. Our dedicated employees work in almost ninety countries and together we deliver improved competitiveness to clients worldwide. Welcome to Uddeholm.